

1W, Fixed input voltage, isolated & unregulated dual output



Continuous Short Circuit Protection



UL US CE Patent Protection RoHS

FEATURES

- Continuous short-circuit protection
- No-load input current as low as 5mA
- Operating temperature range: -40°C to +105°C
- High efficiency up to 83%
- Compact SMD package
- Isolation voltage: 1.5K VDC
- International standard pin-out
- Meets UL62368, EN62368 standards (Pending)

A05_XT-1WR3 series are specially designed for applications where an isolated voltage is required in a distributed power supply system. They are suitable for: pure digital circuits, low frequency analog circuits, relay-driven circuits and data switching circuits.

Selection Guide

Certification	Part No.	Input Voltage (VDC)	Output		Efficiency (%Min./Typ.) @ Full Load	Max. Capacitive Load (µF)*
		Nominal (Range)	Output Voltage (VDC)	Output Current (mA)(Max./Min.)		
UL/CE (Pending)	A0505XT-1WR3	5 (4.5-5.5)	±5	±100/±10	78/82	1200
	A0509XT-1WR3		±9	±56/±6	79/83	470
	A0512XT-1WR3		±12	±42/±5	79/83	220
	A0515XT-1WR3		±15	±34/±4	79/83	220

Note: *The capacitive loads of positive and negative outputs are identical.

Input Specifications

Item	Operating Conditions	Min.	Typ.	Max.	Unit	
Input Current (full load / no-load)	5VDC input	5VDC output	--	244/5	257/10	mA
		9VDC/12VDC output	--	241/12	254/20	
		15VDC output	--	241/18	254/30	
Reflected Ripple Current*		--	15	--	mA	
Surge Voltage (1sec. max.)	5VDC input	-0.7	--	9	VDC	
Input Filter		Filter capacitor				
Hot Plug		Unavailable				

Note: * Reflected ripple current testing method please see DC-DC Converter Application Notes for specific operation.

Output Specifications

Item	Operating Conditions	Min.	Typ.	Max.	Unit	
Output Voltage Accuracy		See tolerance envelope curve(Fig. 1)				
Line Regulation	Input voltage change: ±1%	--	--	1.2	%/%	
Load Regulation	10%-100% load	5VDC output	--	10	15	%
		9VDC output	--	8	10	
		12VDC output	--	7	10	
		15VDC output	--	6	10	
Ripple & Noise*	20MHz bandwidth	--	30	75	mVp-p	
Temperature Coefficient	Full load	--	±0.02	--	%/°C	
Short Circuit Protection		Continuous, self-recovery				

Note: *Ripple and noise are measured by "parallel cable" method, please see DC-DC Converter Application Notes for specific operation;

General Specifications

Item	Operating Conditions	Min.	Typ.	Max.	Unit
Isolation Voltage	Input-output, with the test time of 1 minute and the leak current lower than 1mA	1500	--	--	VDC
Isolation Resistance	Input-output, isolation voltage 500VDC	1000	--	--	MΩ
Isolation Capacitance	Input-output, 100KHz/0.1V	--	20	--	pF
Operating Temperature	Derating when operating temperature up to 100°C, (see Fig. 2)	-40	--	105	°C
Storage Temperature		-55	--	125	
Casing Temperature Rise	Ta=25°C	--	15	--	
Pin Welding Resistance Temperature	Welding spot is 1.5mm away from the casing, 10 seconds	--	--	300	
Storage Humidity	Non-condensing	--	--	95	%RH
Reflow Soldering Temperature*		Peak temp. ≤245°C, maximum duration time ≤60s at 217°C.			
Switching Frequency	Full load, nominal input voltage	--	270	--	KHz
MTBF	MIL-HDBK-217F@25°C	3500	--	--	K hours
Moisture Sensitivity Level (MSL)	IPC/JEDEC J-STD-020D.1	Level 2			

Note: * For actual application, please refer to IPC/JEDEC J-STD-020D.1.

Physical Specifications

Casing Material	Black flame-retardant and heat-resistant plastic(UL94 V-0)
Dimensions	15.24*11.40*7.25 mm
Weight	1.4g (Typ.)
Cooling Method	Free air convection

EMC Specifications

EMI	CE	CISPR32/EN55032 CLASS B (see Fig. 5 for recommended circuit)
	RE	CISPR32/EN55032 CLASS B (see Fig. 5 for recommended circuit)
EMS	ESD	IEC/EN61000-4-2 Air ±8kV, Contact ±4kV perf. Criteria B

Product Characteristic Curve

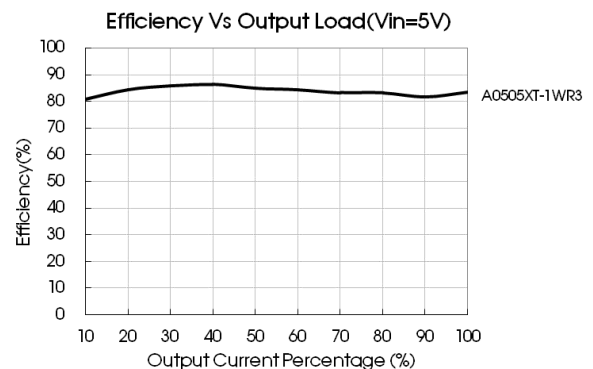
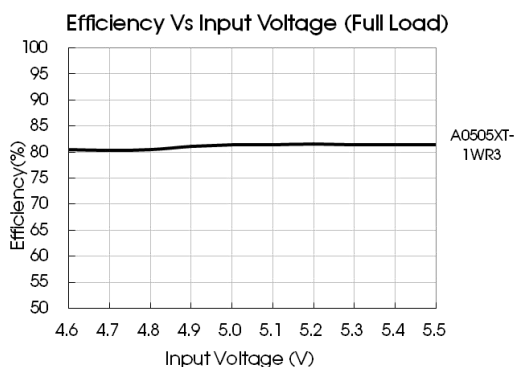
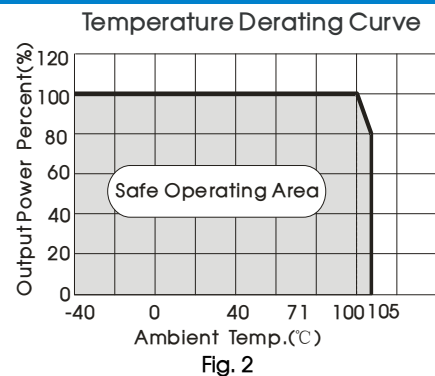
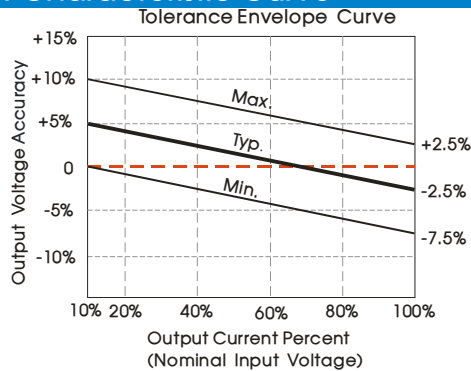

Design Reference

1. Typical application circuit

If it is required to further reduce input and output ripple, a filter capacitor may be connected to the input and output terminals, see Fig.3. Moreover, choosing a suitable filter capacitor is very important, start-up problems may be caused if the capacitance is too large. Under the condition of safe and reliable operation, the recommended capacitive load values are shown in Table 1.

The simplest device for output voltage regulation, over-voltage and over-current protection is a linear voltage regulator with overheat protection that is connected to the input or output end in series (see Fig. 4).

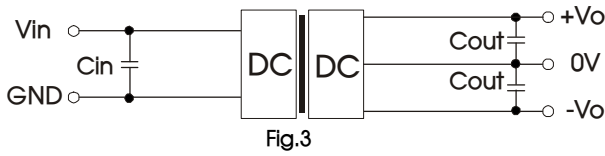

Fig.3

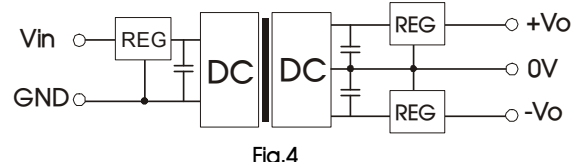

Fig.4

Recommended capacitive load value table (Table 1)

Vin(VDC)	Cin(μF)	Vo (VDC)	Cout(μF)
5	4.7	±5	4.7
		±9	2.2
		±12	1
		±15	1

2. EMC solution-recommended circuit

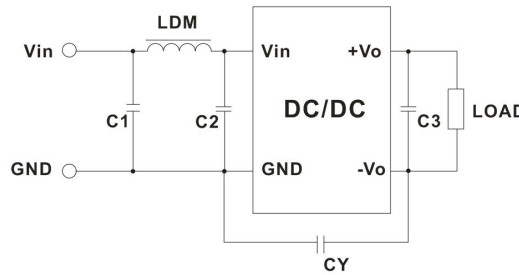

Fig. 5

EMC recommended circuit value table (Table 2)

Input voltage 5VDC	Output voltage(VDC)	5/9	12/15
		EMI	C1/C2 4.7μF /25V
		CY --	1nF/2KVDC HEC C1206X102K202T JOHANSON 202R18W102KV4E
		C3	Refer to the Cout in table 1
		LDM	6.8μH

Note: In the case of actual use, the requirements for EMI are high, it is subject to CY.

3. For more information please find DC-DC converter application notes on www.mornsun-power.com

Dimensions and Recommended Layout

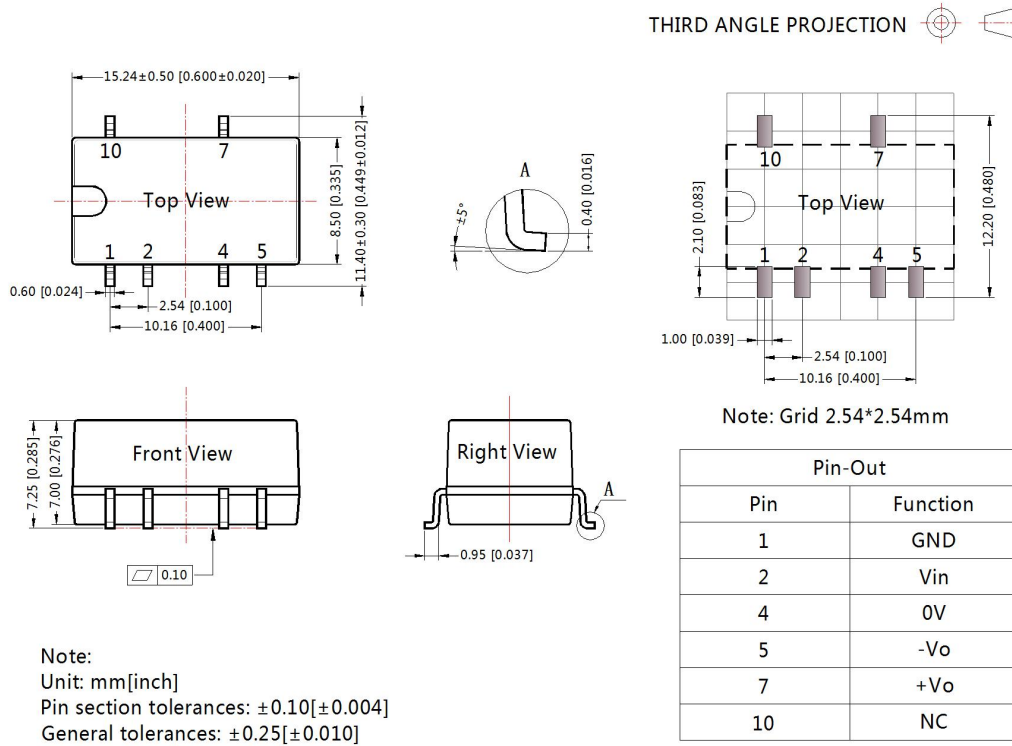

NC: Pin to be isolated from circuitry

Notes:

1. Packing information please refer to Product Packing Information which can be downloaded from www.mornsun-power.com. Tube Packing bag number: 58210023, Roll Packing bag number: 58210034;
2. If the product is not operated within the required load range, the product performance cannot be guaranteed to comply with all parameters in the datasheet;
3. The maximum capacitive load offered were tested at input voltage range and full load;
4. Unless otherwise specified, parameters in this datasheet were measured under the conditions of $T_a=25^\circ\text{C}$, humidity<75%RH with nominal input voltage and rated output load;
5. All index testing methods in this datasheet are based on our Company's corporate standards;
6. We can provide product customization service, please contact our technicians directly for specific information;
7. Products are related to laws and regulations: see "Features" and "EMC";
8. Our products shall be classified according to ISO14001 and related environmental laws and regulations, and shall be handled by qualified units.

MORNSUN Guangzhou Science & Technology Co., Ltd.

Address: No. 5, Kehui St. 1, Kehui Development Center, Science Ave., Guangzhou Science City, Luogang District, Guangzhou, P. R. China
Tel: 86-20-38601850-8801 Fax: 86-20-38601272 E-mail: info@mornsun.cn